

UPTOWN<sup>®</sup>  
CONTEMPORARY RANGE

UTR3

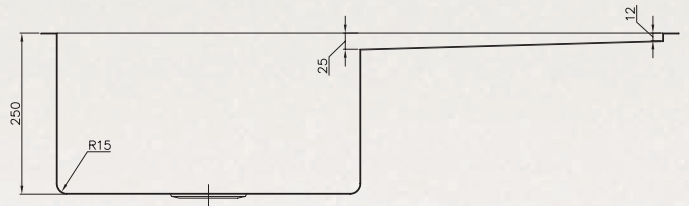
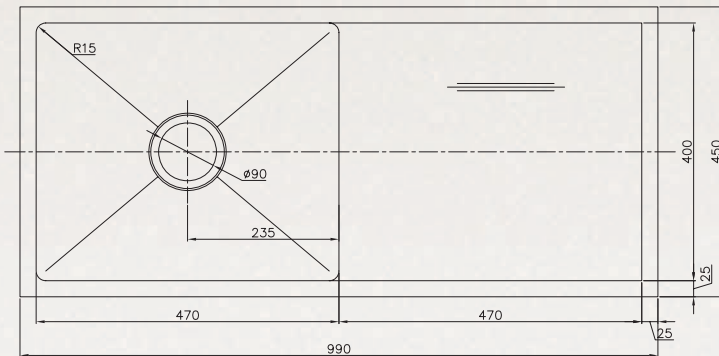

VICTORIA & TASMANIA  
Interchange Sales & Marketing P/L  
Unit 4/49 Corporate Blvd Bayswater Vic 3153  
Ph: 03 9729 6411 | Fax: 03 9729 5722  
interchange@netspace.net.au  
www.interchangesales.com.au

## 250 Series - Drainer Sinks

- Suitable for **top-mount** (clips supplied) or **under-mount**.
- Made from **1.2mm 18/10** stainless steel.
- Sinks are **250mm deep**.
- Comes complete with 90mm designer basket waste.
- Alternate sizes available in project quantities.